

## FEATURES

- 30 Volt Differential Input Range
- 75 nA Input Bias Current
- Wide Common Mode Voltage Range

## APPLICATIONS

- Signal Conditioning Amplifiers
- Voltage Followers
- Comparators

## DESCRIPTION

The LM101A and LM107 are general purpose operational amplifiers, featuring low bias current and the ability to operate with high input differential voltages up to 30 Volts. Unlike many FET input amplifiers, the output of the LM101A/107 does not reverse if the common mode range is exceeded, making them particularly useful in comparator and oscillator circuits.

The LM101A uses external compensation, allowing the frequency response and slew rate to be optimized for the application. The LM107 is identical to the LM101A with the exception that the compensation capacitor is internal. Linear's LM101A and LM107 include improved design and processing techniques resulting in superior long term stability and reliability over previous devices. The curve of bias current versus differential input voltage indicates that a minimal change in input current occurs over a wide range of input signal, which is important in many applications.

### Wein Bridge Sine Wave Oscillator

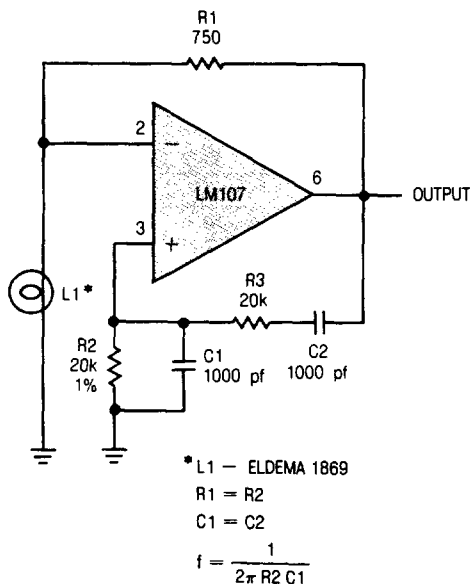

### Bias Current vs Differential Input Voltage

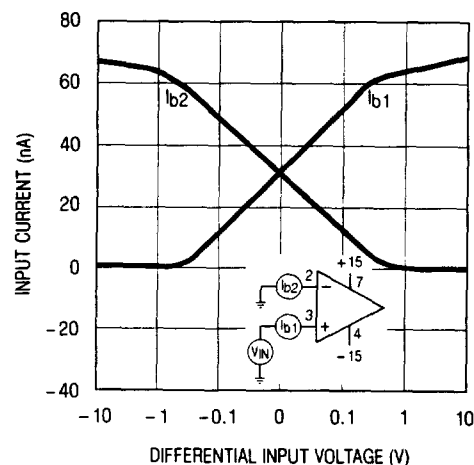

## ABSOLUTE MAXIMUM RATINGS

Supply Voltage		
LM101A/LM107	.....	± 22 Volts
LM301A/LM307	.....	± 18 Volts
Differential Input Voltage	.....	± 30 Volts
Input Voltage, Note 2	.....	± 15 Volts
Output Short Circuit Duration, Note 3	.....	Indefinite
Operating Temperature Range		
LM101A/LM107	.....	-55°C to 125°C
LM301A/LM307	.....	0°C to 70°C
Maximum Junction Temperature		
LM101A/LM107	.....	150°C
LM301A/LM307	.....	100°C
Storage Temperature Range		
All Devices	.....	-65°C to 150°C
Lead Temperature (Soldering, 10 sec.)	.....	300°C

## PACKAGE/ORDER INFORMATION

<p>METAL CAN H PACKAGE * PINS 1, 5, 8 NO CONNECTION ON LM107/307</p>	ORDER PART NUMBER
	LM101AH LM301AH LM107H LM307H
<p>J8 PACKAGE HERMETIC DIP * PINS 1, 5, 8 NO CONNECTION ON LM107/307</p>	LM101AJ8 LM301AJ8 LM107J8 LM307J8

## ELECTRICAL CHARACTERISTICS (Note 1)

SYMBOL	PARAMETER	CONDITIONS	LM101A/LM107			LM301A/LM307			UNITS
			MIN	TYP	MAX	MIN	TYP	MAX	
$V_{OS}$	Input Offset Voltage	$R_S \leq 50K\Omega$ , $T_A = 25^\circ C$ $R_S \leq 50K\Omega$	●	0.7	2.0	2.0	7.5	mV	
$\frac{\Delta V_{OS}}{\Delta Temp}$	Average Temperature Coefficient of Input Offset Voltage	$R_S \leq 50K\Omega$	●	3.0	15	6.0	30	$\mu V/^\circ C$	
$I_{OS}$	Input Offset Current	$T_A = 25^\circ C$	●	1.5	10	3.0	50	nA	
$\frac{\Delta I_{OS}}{\Delta Temp}$	Average Temperature Coefficient of Input Offset Current	$25^\circ C \leq T_A \leq T_{MAX}$ $T_{MIN} \leq T_A \leq 25^\circ C$		0.01	0.1	0.01	0.3	nA/°C	
$I_B$	Input Bias Current	$T_A = 25^\circ C$	●	30	75	70	250	nA	
$A_{VOL}$	Large Signal Voltage Gain	$T_A = 25^\circ C$ , $V_S = \pm 15V$ , $V_{OUT} = \pm 10V$ , $R_L \geq 2K\Omega$ $V_S = \pm 15V$ , $V_{OUT} = \pm 10V$ , $R_L \geq 2K\Omega$	●	50	160	25	160	V/mV	
			●	25		15		V/mV	
CMRR	Common Mode Rejection Ratio	$R_S \leq 50K\Omega$	●	80	96	70	90	dB	
PSRR	Power Supply Rejection Ratio	$R_S \leq 50K\Omega$	●	80	96	70	96	dB	
	Input Voltage Range	$V_S = \pm 20V$ $V_S = \pm 15V$	●	± 15				V	
			●	+ 15		± 12	+ 15	V	
			●	- 13		- 13		V	
$V_{OUT}$	Output Voltage Swing	$V_S = \pm 15V$ , $R_L = 10K\Omega$ $R_L = 2K\Omega$	●	± 12	± 14	± 12	± 14	V	
			●	± 10	± 13	± 10	± 13	V	
$R_{IN}$	Input Resistance	$T_A = 25^\circ C$		1.5	4.0	0.5	2.0	M $\Omega$	
$I_S$	Supply Current	$T_A = 25^\circ C$ , $V_S = \pm 20V$	●	1.8	3.0	1.8	3.0	mA	
		$T_A = 125^\circ C$ , $V_S = \pm 20V$	●	1.2	2.5			mA	

The ● denotes the specifications which apply over the full operating temperature range.

**Note 1:** Unless otherwise noted; all measurements are made with unity gain compensation ( $C_1 = 30\text{pf}$  for the LM101A/301A); these specifications apply for  $\pm 5V \leq V_S \leq \pm 20V$  for the LM101A/LM107; and  $\pm 5V \leq V_S \leq \pm 15V$  for the LM301A/LM307.

**Note 2:** For supply voltages less than ± 15 Volts, the maximum input voltage is equal to the supply voltage.

**Note 3:** The output may be shorted to ground or either power supply indefinitely, provided the case temperature is below 125°C for the LM101A/107 and below 70°C for the LM301A/307.

# TYPICAL PERFORMANCE CHARACTERISTICS (LM101A)

## Single Pole Compensation

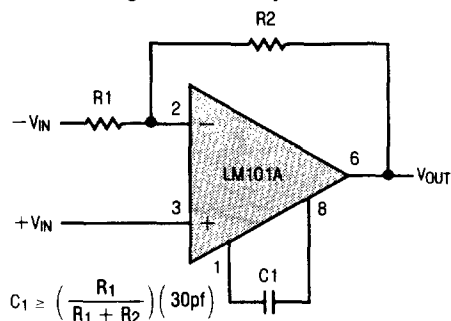

$$C_1 \geq \left( \frac{R_1}{R_1 + R_2} \right) (30 \text{ pf})$$

$C_1 = 30 \text{ pF}$  for unity gain stability. At gains above 1 frequency response can be maximized by decreasing  $C_1$ .

## Open Loop Frequency Response

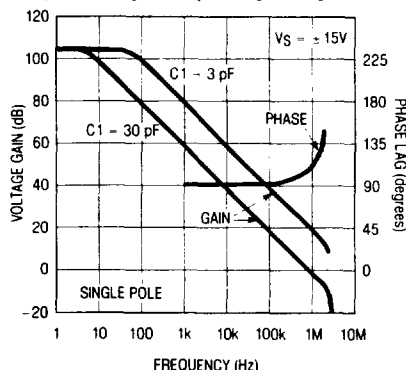

## Single Pole Large Signal Frequency Response

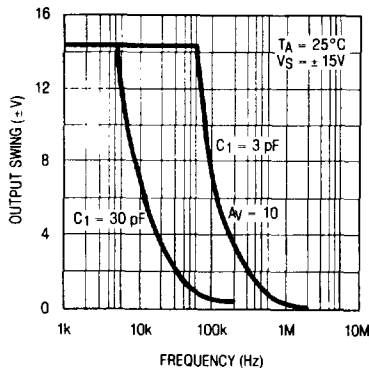

## Single Pole Voltage Follower Pulse Response

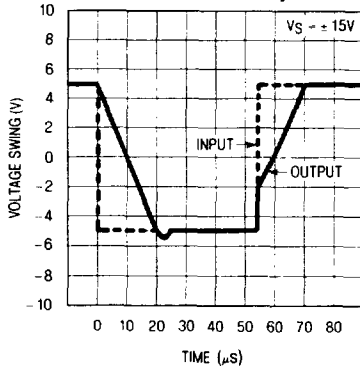

## Two Pole Compensation

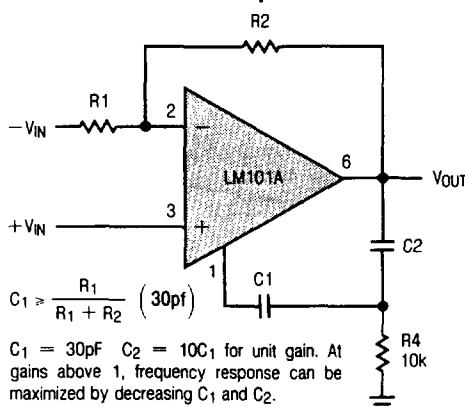

$$C_1 \geq \frac{R_1}{R_1 + R_2} (30 \text{ pf})$$

$C_1 = 30 \text{ pF}$   $C_2 = 10C_1$  for unit gain. At gains above 1, frequency response can be maximized by decreasing  $C_1$  and  $C_2$ .

## Open Loop Frequency Response

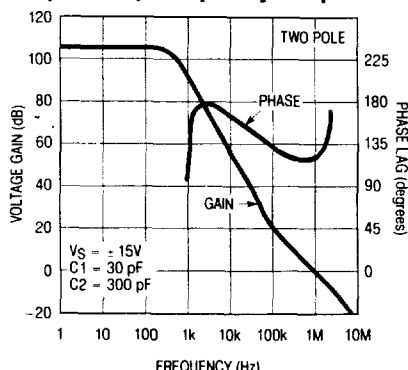

## 2 Pole Large Signal Frequency Response

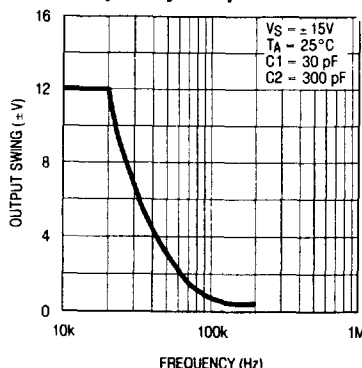

## 2 Pole Voltage Follower Pulse Response

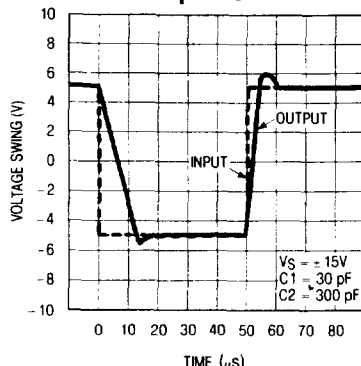

## Feedforward Compensation

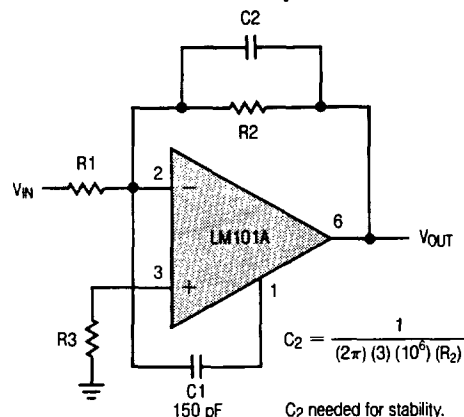

$$C_2 = \frac{1}{(2\pi)(3)(10^6)(R_2)}$$

$C_2$  needed for stability.

## Open Loop Frequency Response

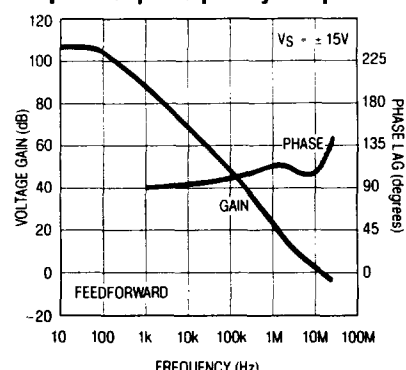

## Feedforward Large Signal Frequency Response

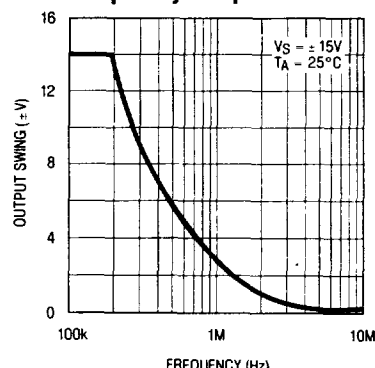

## Feedforward Inverter Pulse Response

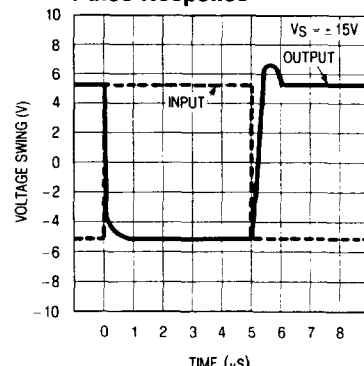

2

**TYPICAL PERFORMANCE CHARACTERISTICS** (LM101A/LM107)

**Input Current**

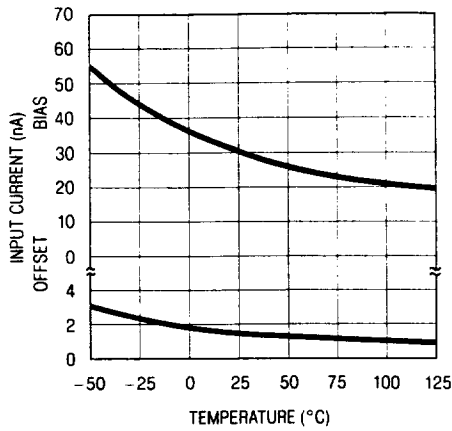

**Supply Current**

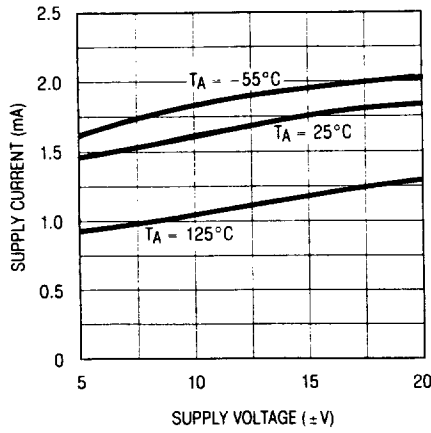

**Voltage Gain**

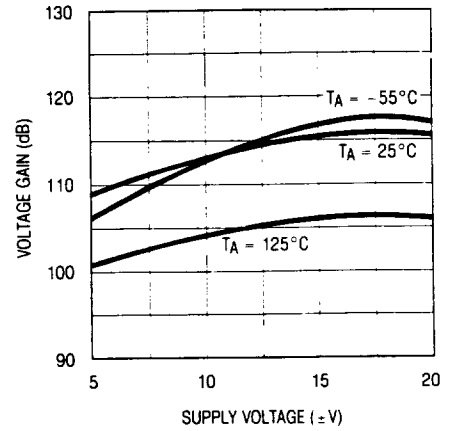

**Input Noise Voltage**

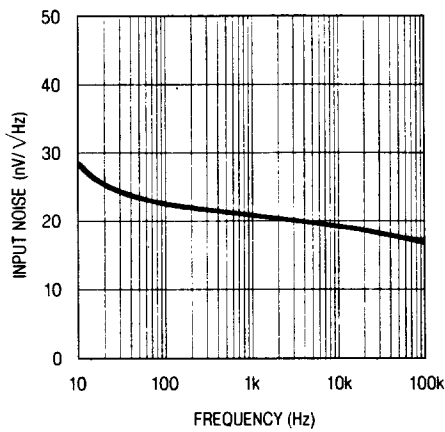

**Input Noise Current**

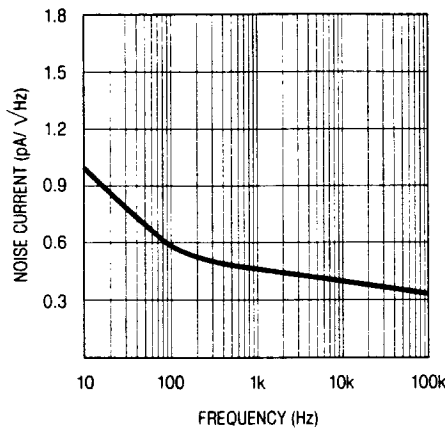

**Current Limiting**

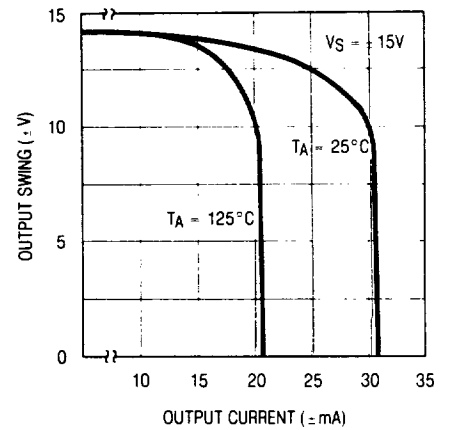

**Common Mode Rejection**

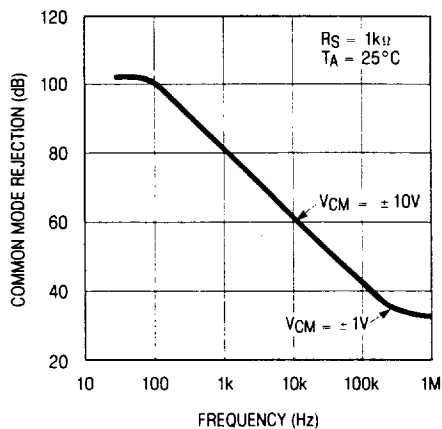

**Power Supply Rejection**

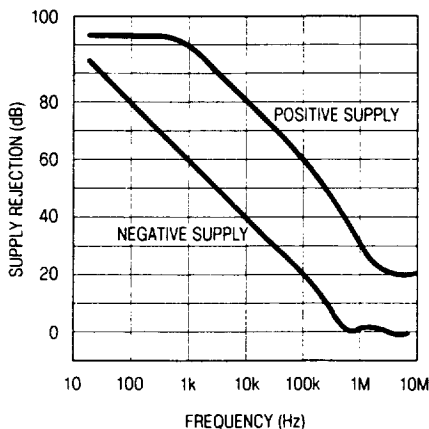

**Closed Loop Output Impedance**

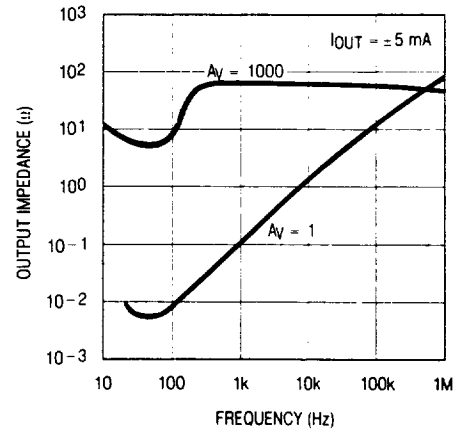

**LM107**  
**Open Loop Frequency Response**

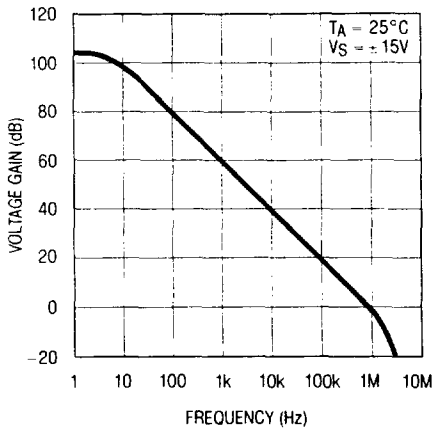

**LM107**  
**Large Signal Frequency Response**

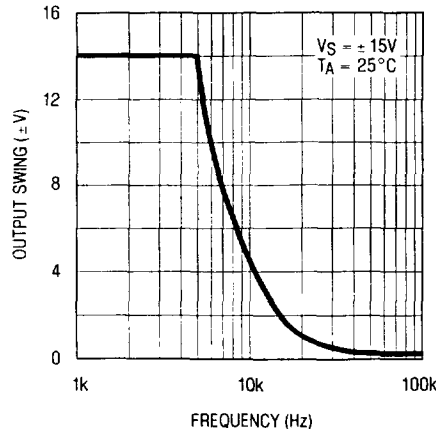

**LM107**  
**Voltage Follower Pulse Response**

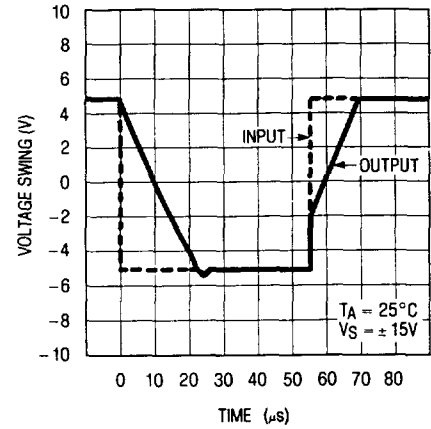

## TYPICAL APPLICATIONS

2

**Standard Compensation and Offset Balancing Circuit**

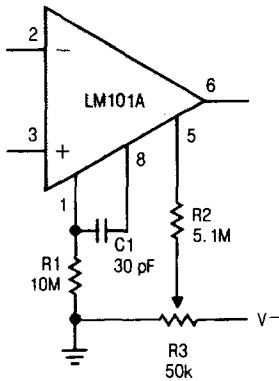

**Fast Summing Amplifier**

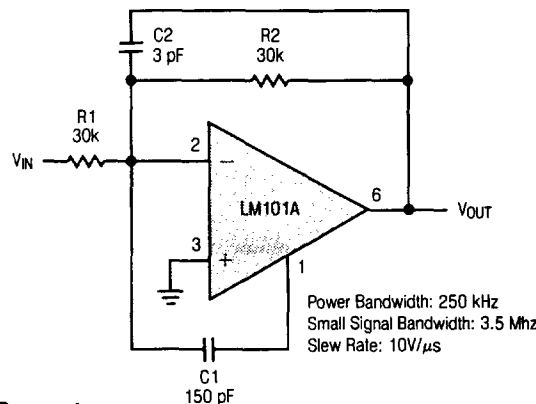

**Fast Voltage Follower**

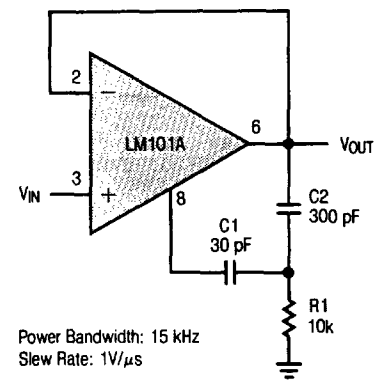

**Low Frequency Square Wave Generator**

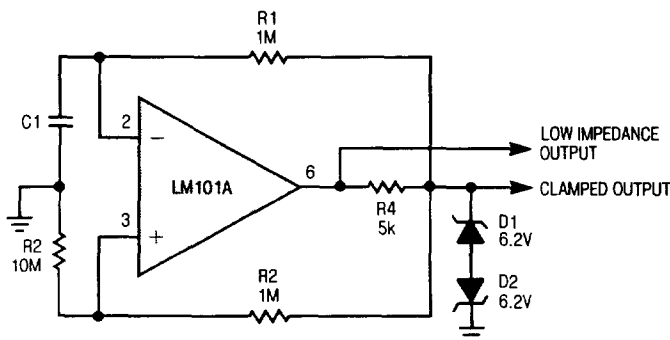

**Voltage Comparator with Clamp**

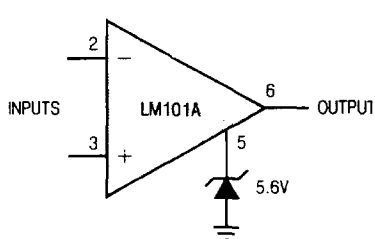

**Precision Rectifier**

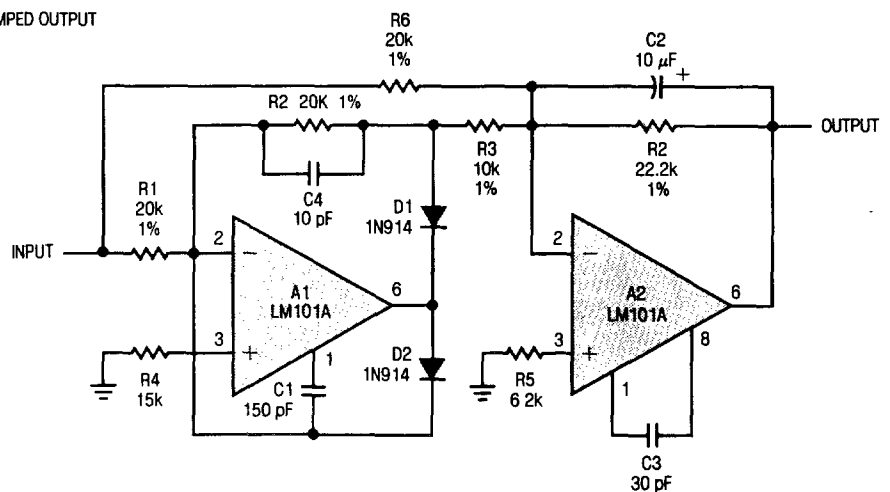

# SCHEMATIC DIAGRAM

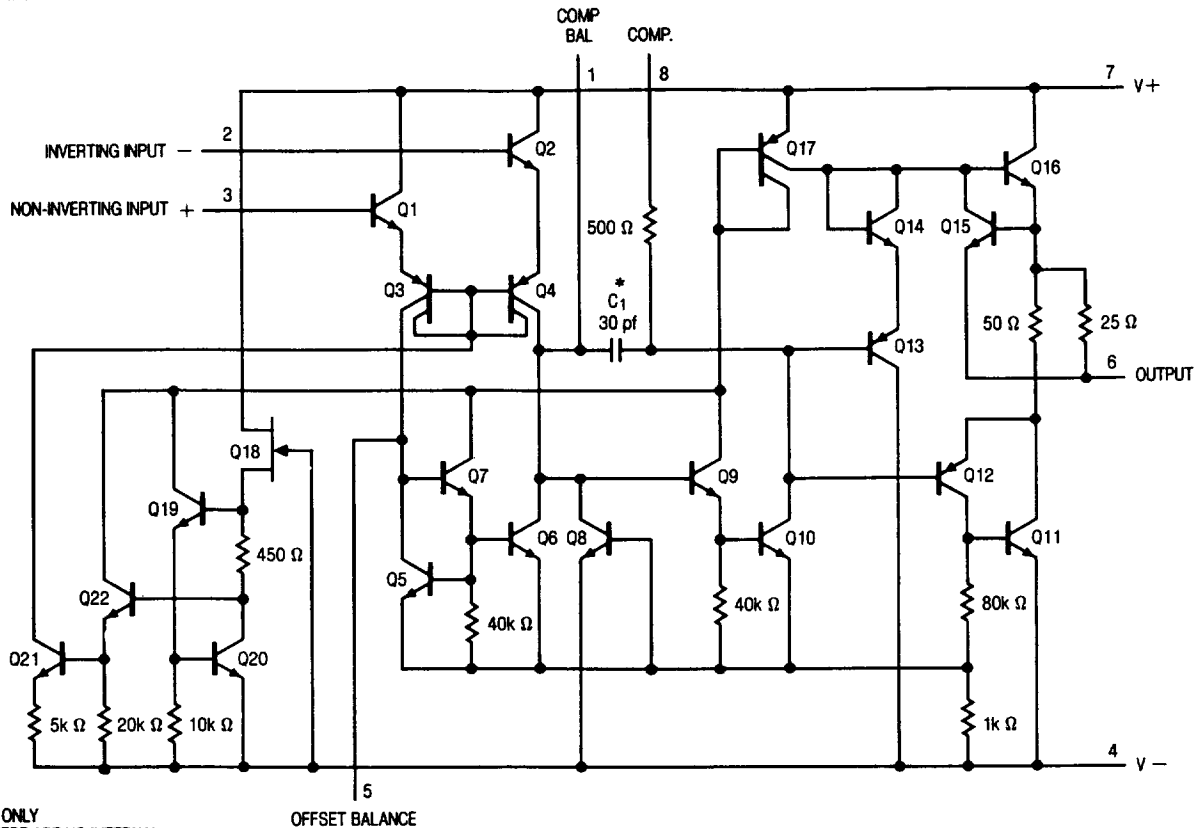

\* C1 FOR LM107 ONLY  
FOR LM107, THERE ARE NO INTERNAL  
CONNECTIONS TO PINS 1, 5 AND 8

# PACKAGE DESCRIPTION

**H Package  
Metal Can**

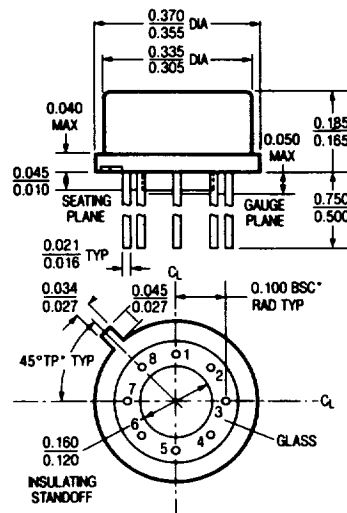

NOTE: DIMENSIONS IN INCHES

$T_{jmax}$	$\theta_{ja}$	$\theta_{jc}$
150°C	150°C/W	45°C/W

**J8 Package  
8 Lead Hermetic Dip**

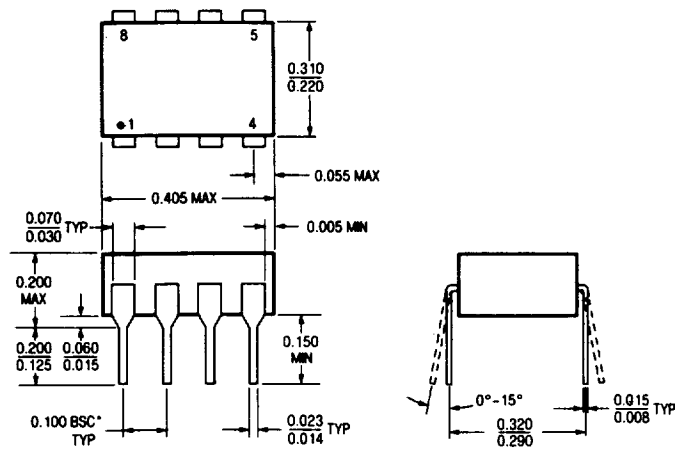

NOTE: DIMENSIONS IN INCHES UNLESS OTHERWISE NOTED.  
\*LEADS WITHIN 0.007 OF TRUE POSITION (TP) AT GAUGE PLANE

$T_{jmax}$	$\theta_{ja}$
150°C	100°C/W